

SCHOOL YEAR: 2021-2022

ACTIVITY BOOK

English

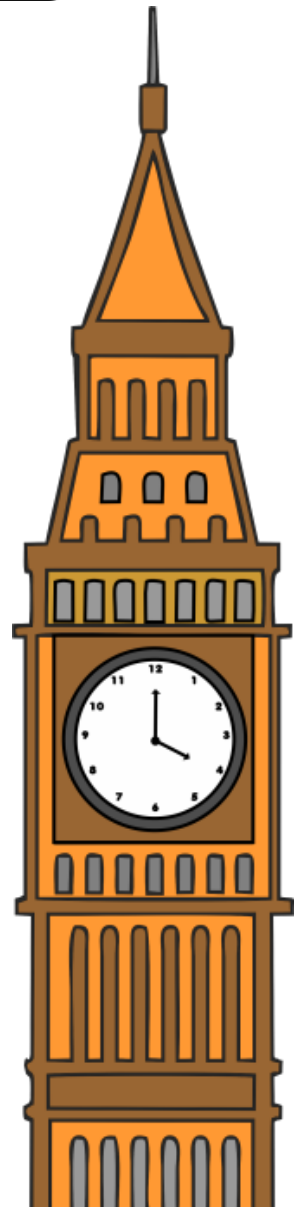

TEACHER: Esther

PUPIL:

CLASS:

UNIT 1



My House

Worksheet number: five

Name: _____

Date: _____

Find the words and label.

This is my house.

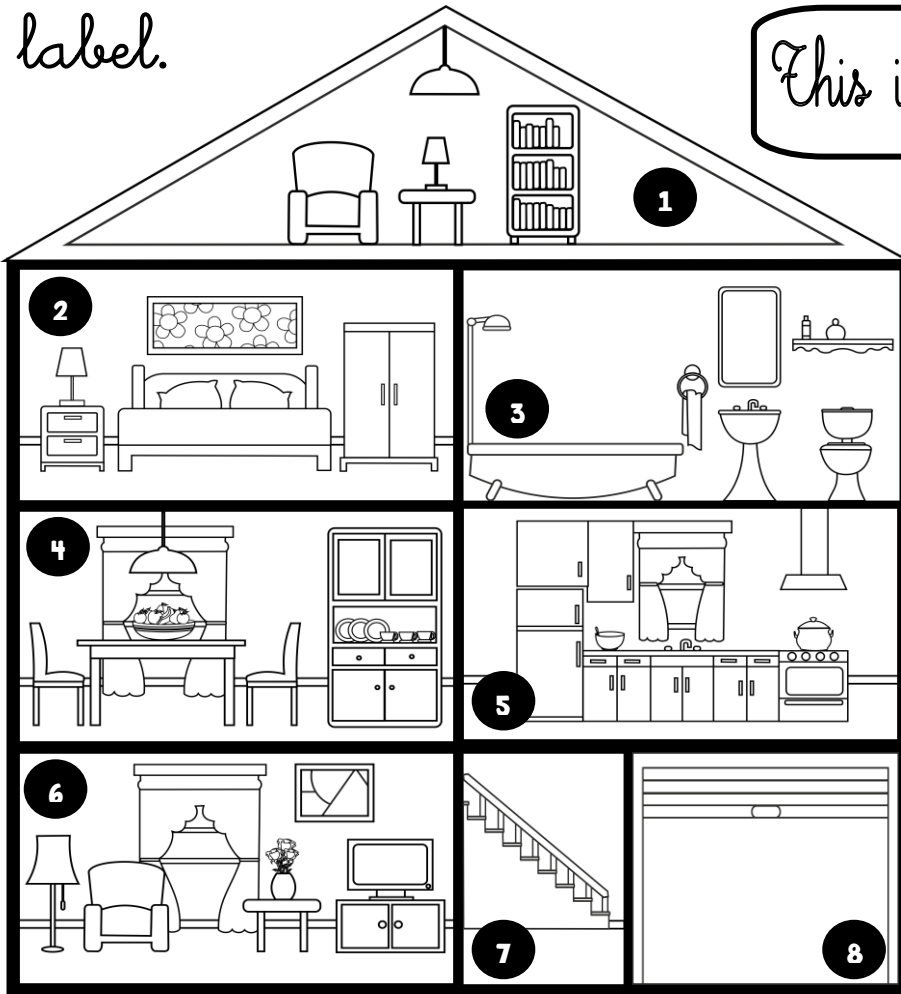

1. attic
2. bedroom
3. bathroom
4. dining room
5. kitchen
6. living room
7. hall
8. garage

C	B	E	D	R	I	Y	T	B	T	R	G	H	N
A	I	V	E	B	E	D	R	O	O	M	A	A	G
T	D	I	N	I	N	G	R	O	O	M	R	L	A
T	E	A	L	A	I	O	T	L	O	N	A	L	R
I	U	L	I	V	I	N	G	R	O	O	M	A	A
C	B	A	T	H	R	O	O	M	E	N	E	N	G
T	E	D	K	I	T	C	H	E	N	E	N	E	E

My House

Worksheet number: six

Name: _____

Date: _____

Unscramble the words

and label the pictures.

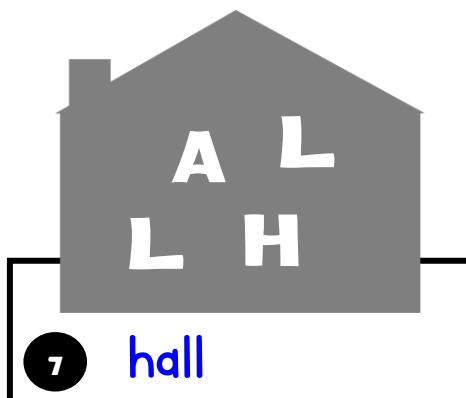
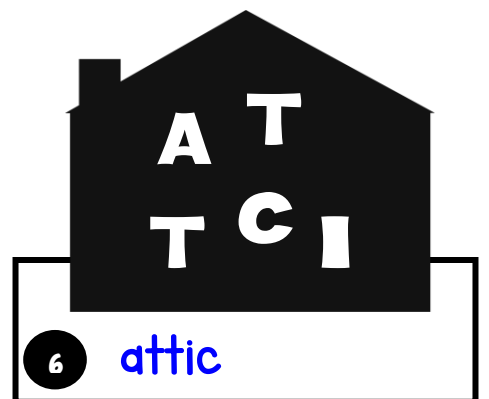
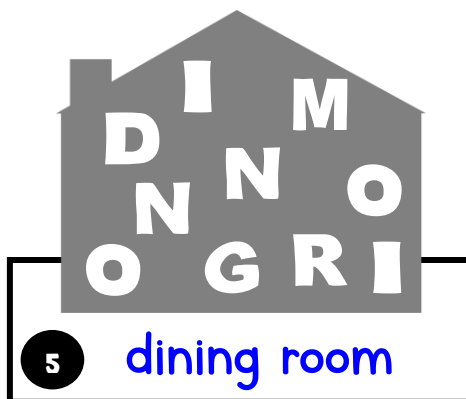
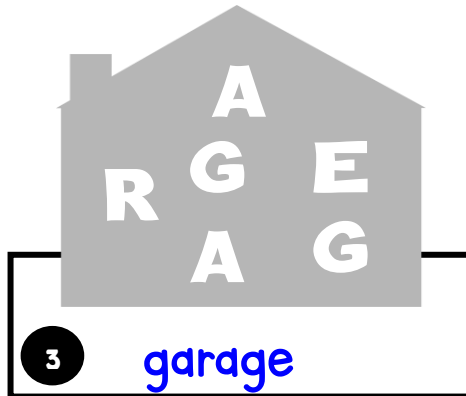
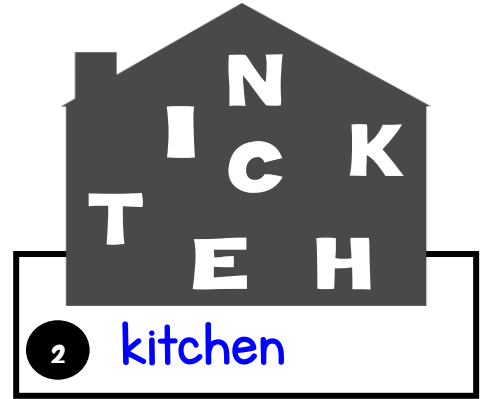
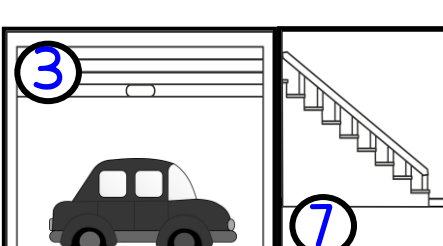
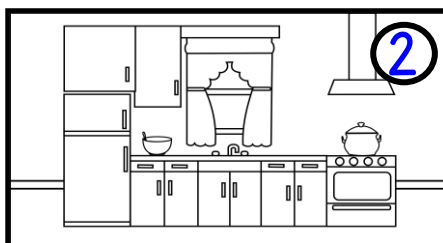
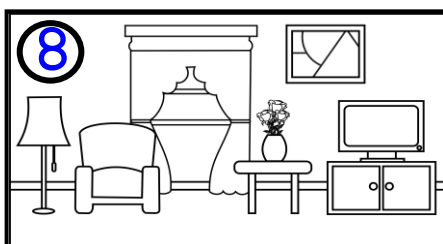
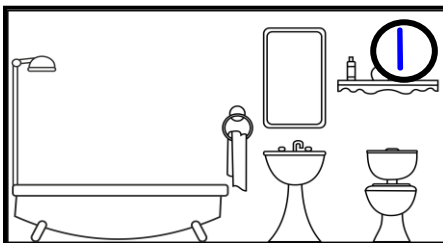
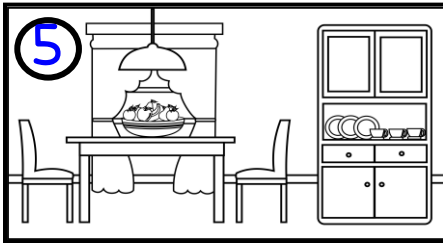
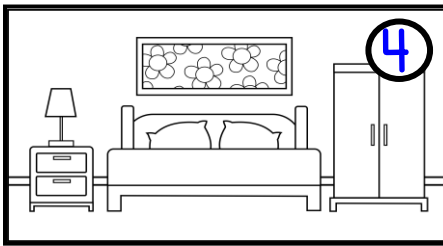
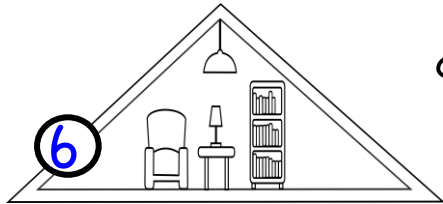

My House

Worksheet number: seven

Name: _____

Date: _____

Do the crossword.

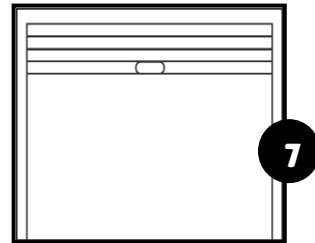
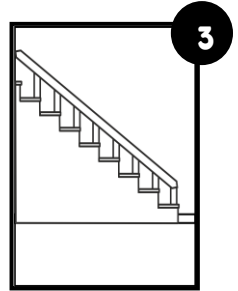
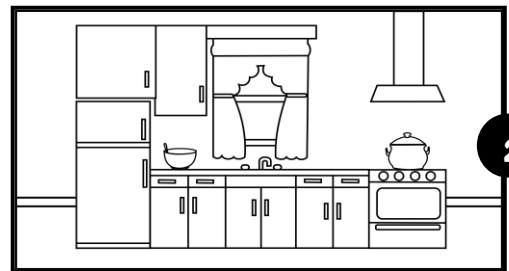
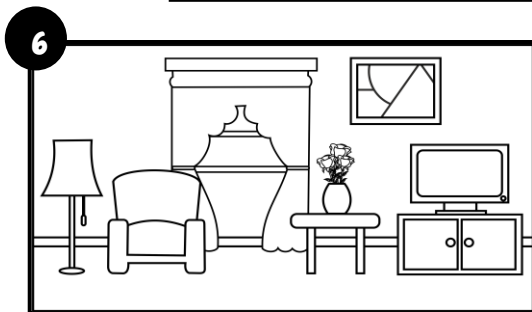
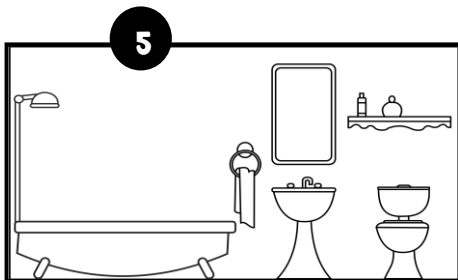
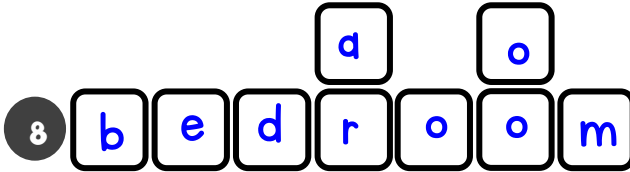
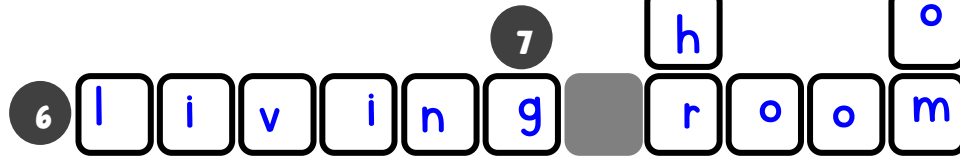
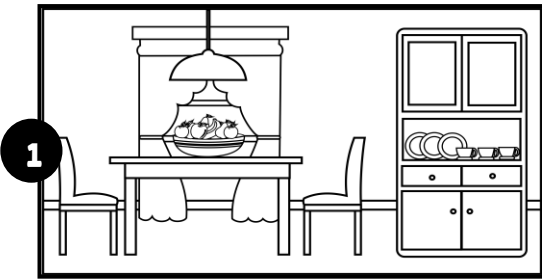
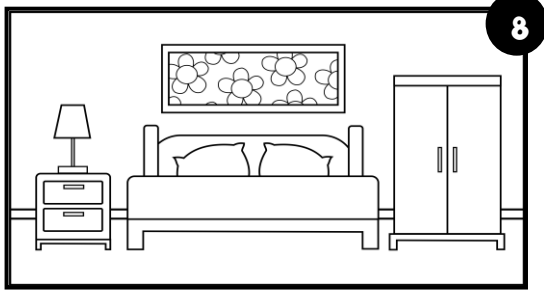
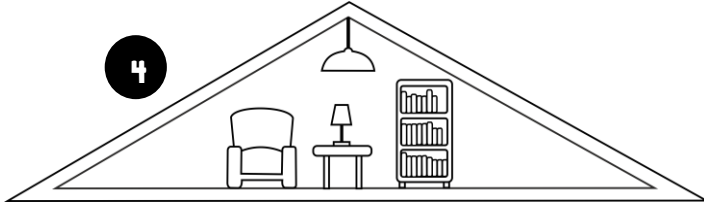

1 d

2 k i t c h e n

3 a

4 a t t i c

5 b a t h r o o m

6 l i v i n g r o o m

7 a o m

8 b e d r o o m

9 a g e

My House

Worksheet number: eight

Name: _____

Date: _____

Read the sentences,
cut the pictures
and paste them in the
correct compartment.

Where is everybody?

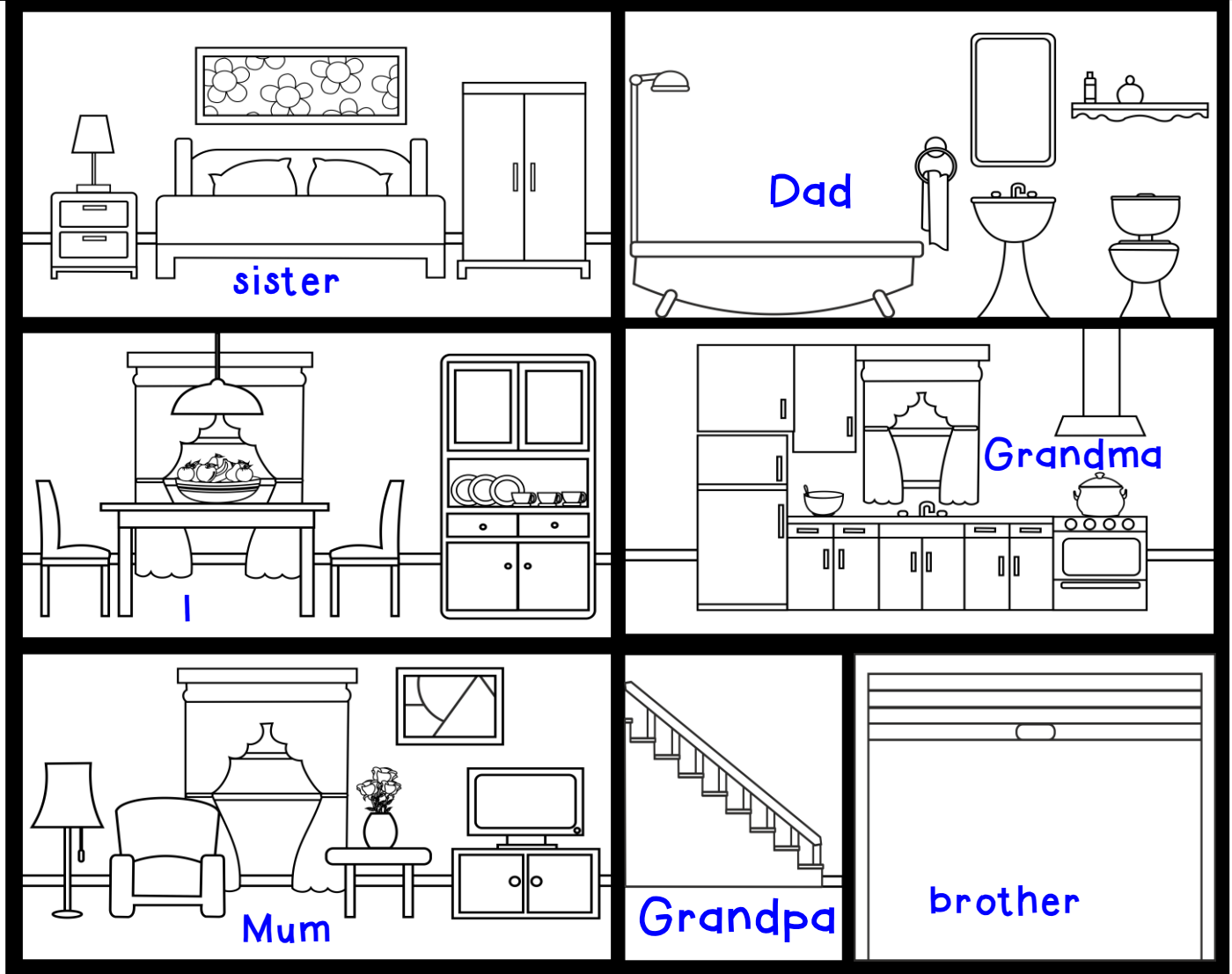

*Dad is in the bathroom.

*My cat is in the attic.

*Grandpa is in the hall.

*Grandma is in the kitchen.

*Mum is in the living room.

*My sister is in the bedroom.

*I am in the dining room.

*My brother is in the garage.

My House

Worksheet number: nine

Name: _____

Date: _____



Find the words and label the pictures.

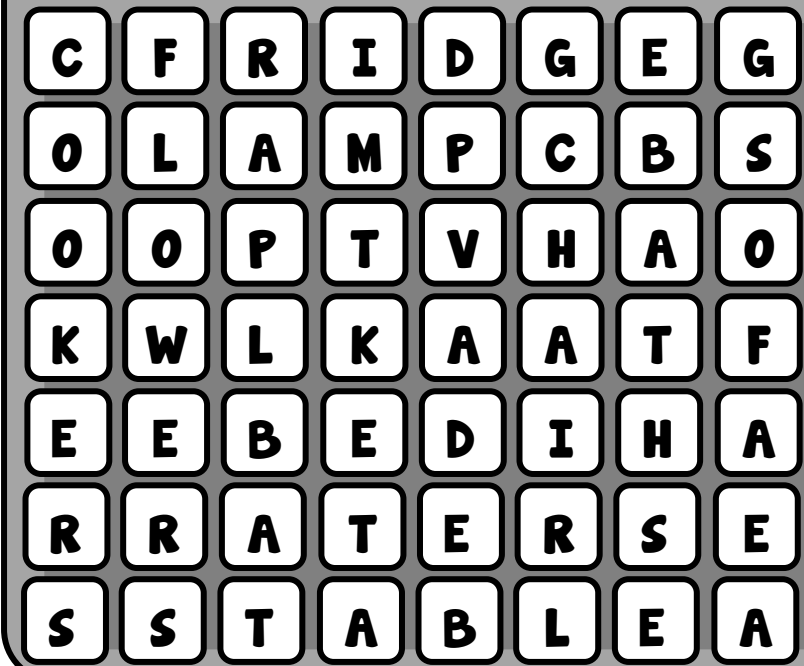

1. cooker
2. chair
3. bed
4. lamp
5. table
6. TV
7. fridge
8. sofa
9. flowers
10. bath

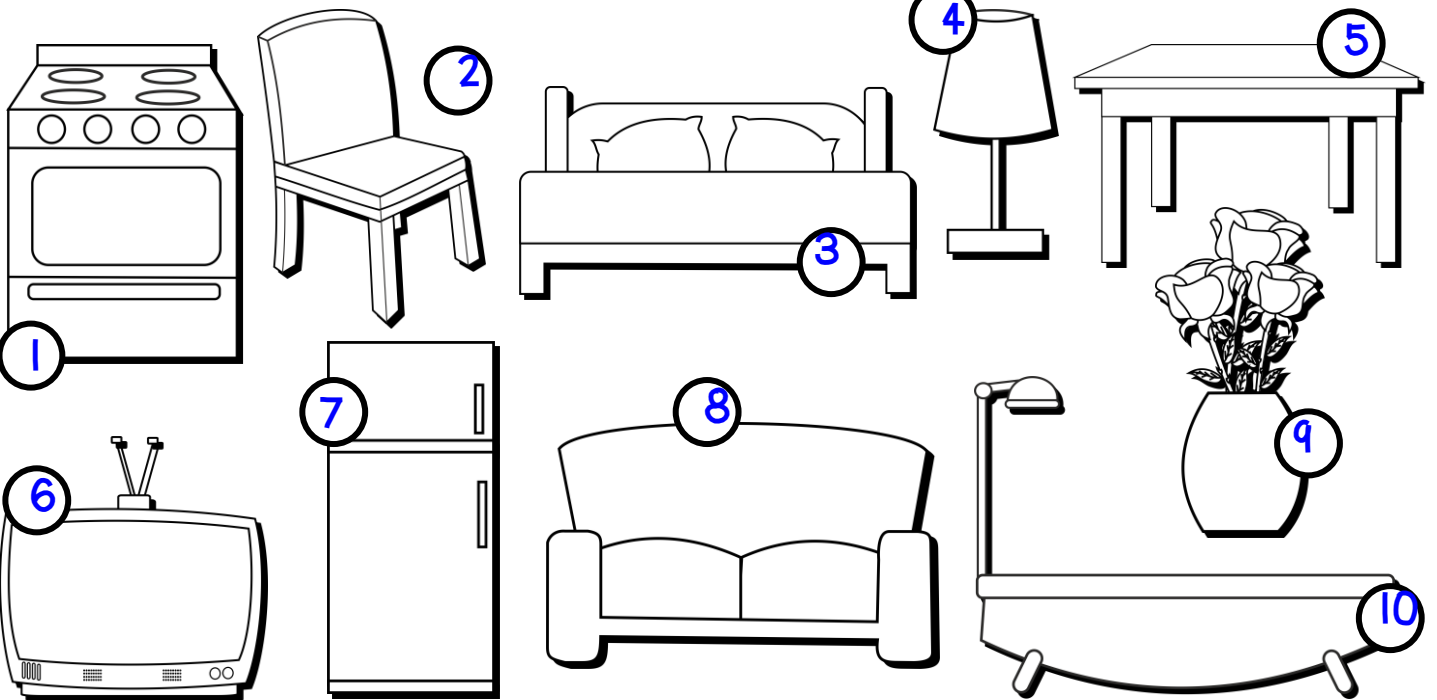

My House

Worksheet number: ten

Name: _____

Date: _____

Label the picture.

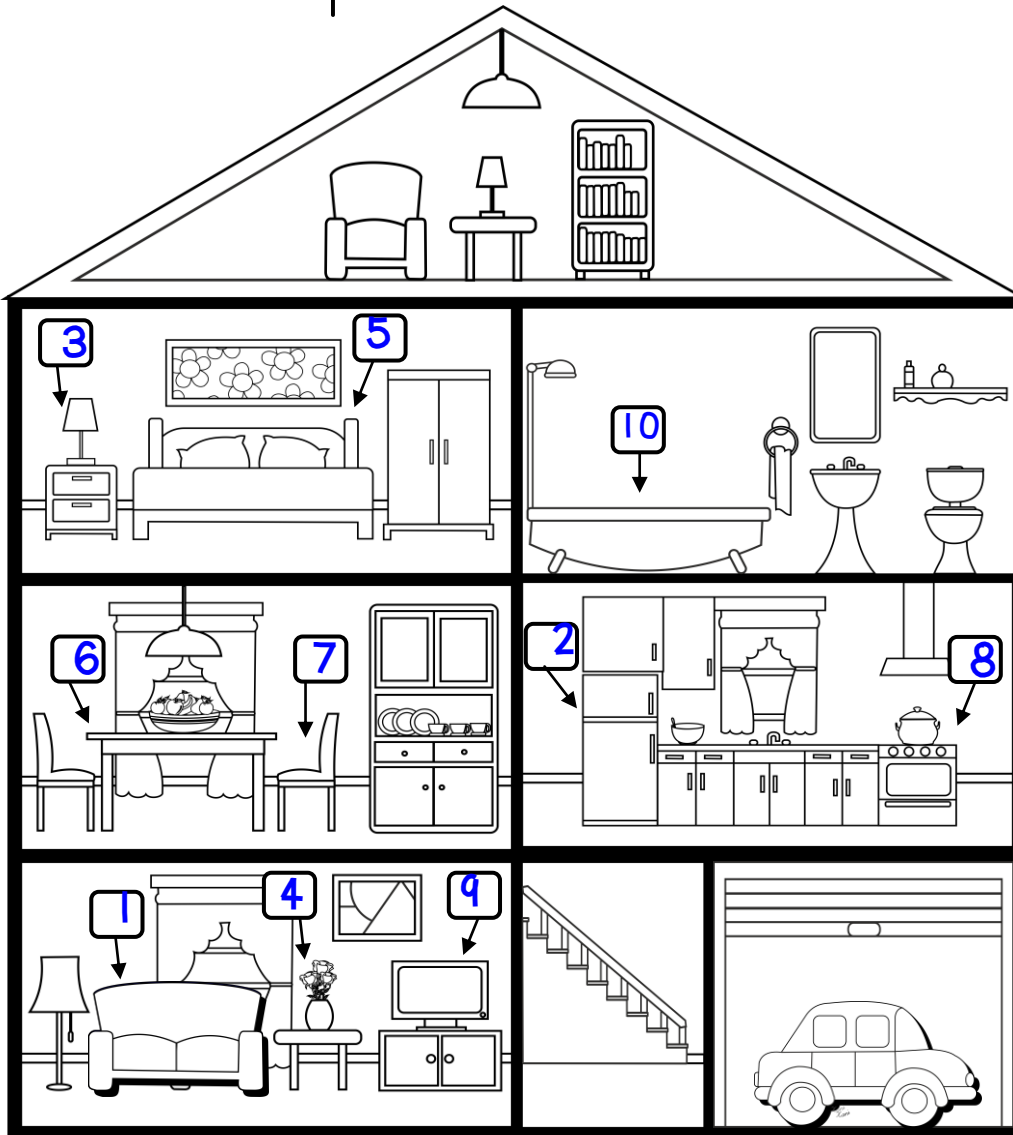

- 1 sofa
- 2 fridge
- 3 lamp
- 4 flowers
- 5 bed
- 6 table
- 7 chair
- 8 cooker
- 9 TV
- 10 bath

Complete the sentences.

1. The sofa is in the living room
2. The fridge is in the kitchen
3. The bed is in the bedroom

4. The chair is in the dining room
5. The bath is in the bathroom
6. The car is in the garage

My Dream House

Worksheet number: eleven

Name: _____

Date: _____

Create your dream house by drawing the furniture/objects.

ATTIC 1

HALL 7

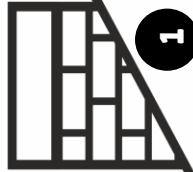

BEDROOM

GARAGE 8

DINING ROOM

LIVING ROOM

BATHROOM

KITCHEN

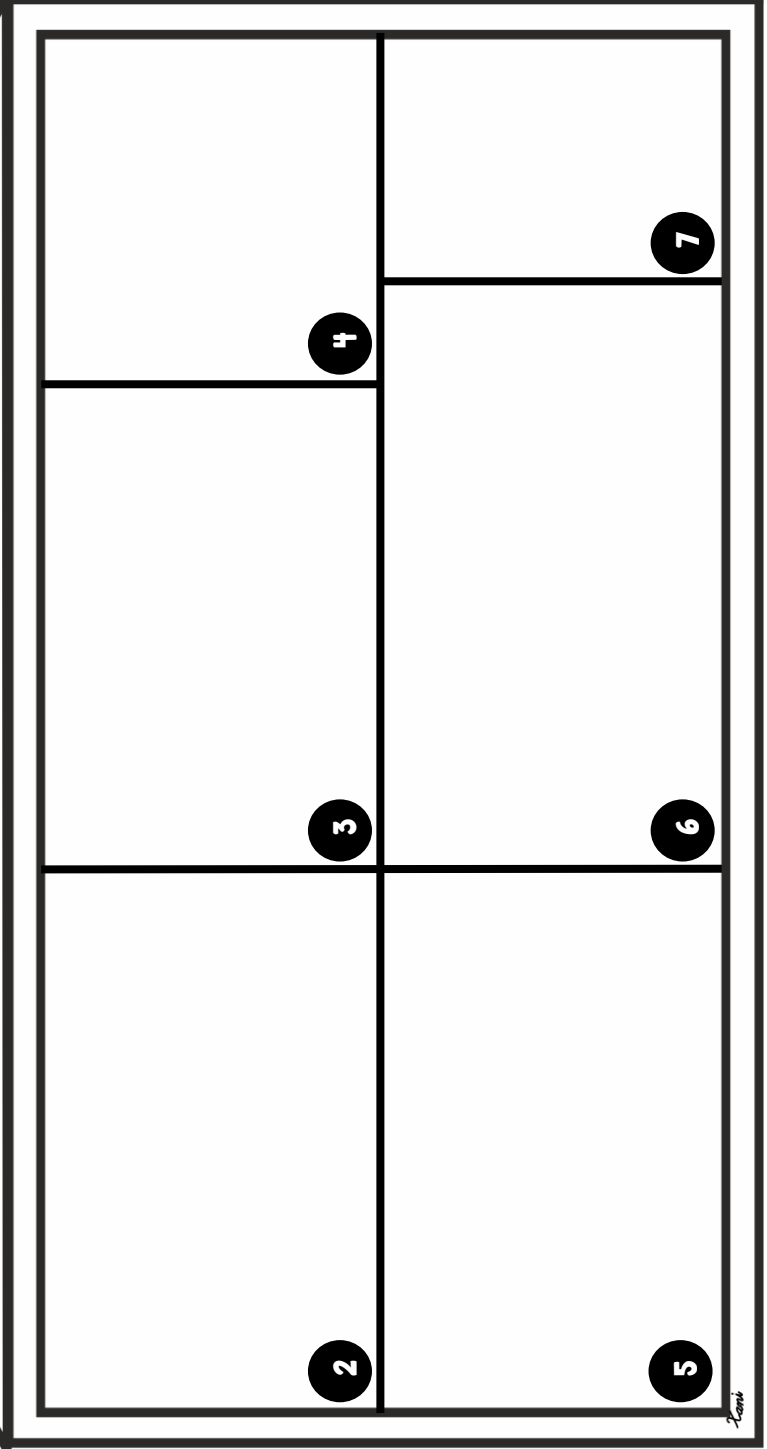

My House

Worksheet number: twelve

Name: _____

Date: _____

Unscramble the words and label the pictures.

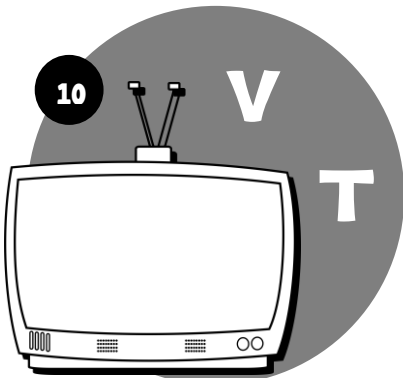
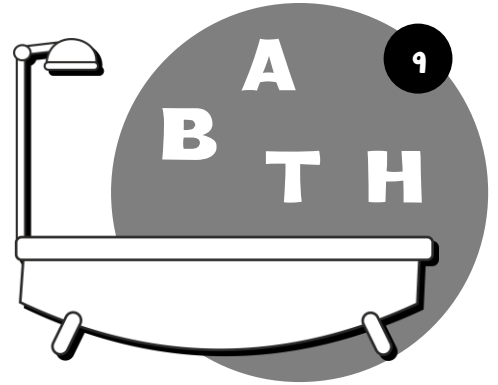
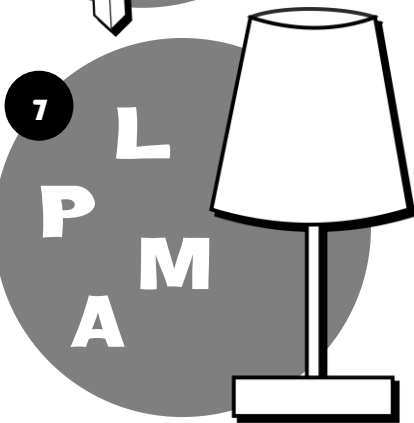
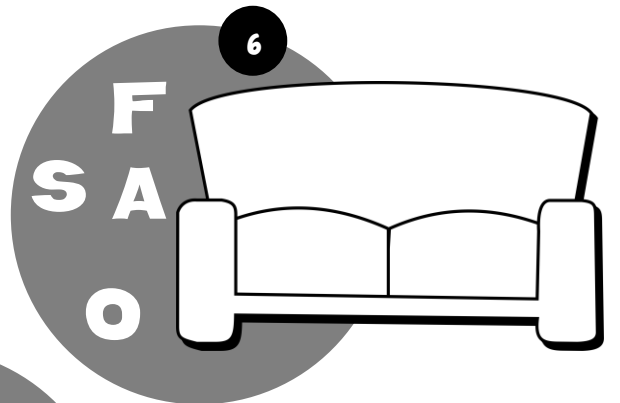
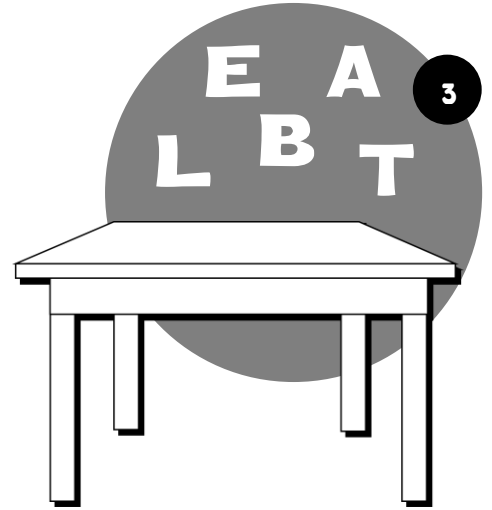
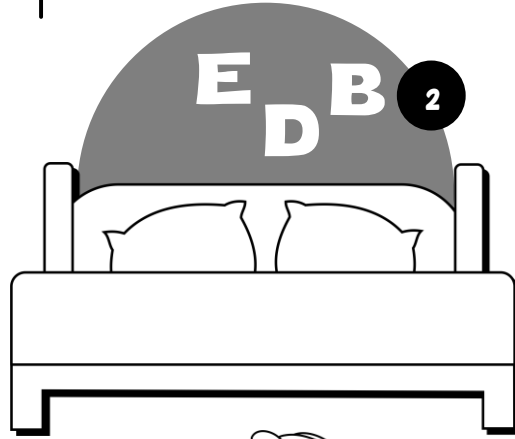
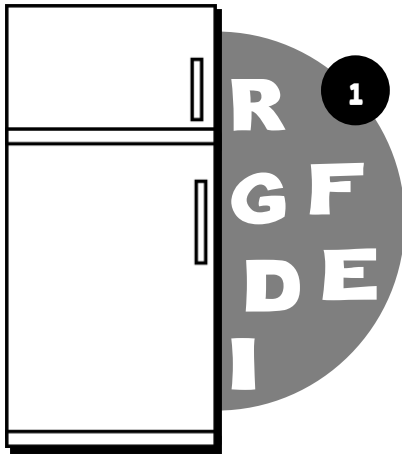

1. fridge _____
2. bed _____
3. table _____
4. chair _____
5. flowers _____

6. sofa _____
7. lamp _____
8. cooker _____
9. bath _____
10. TV _____

On Under

Worksheet number: thirteen

Name: _____

Date: _____

Where is the ant?

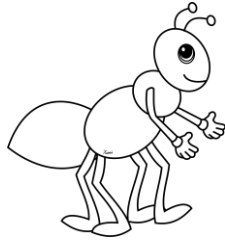

Look and tick (✓) the correct preposition.

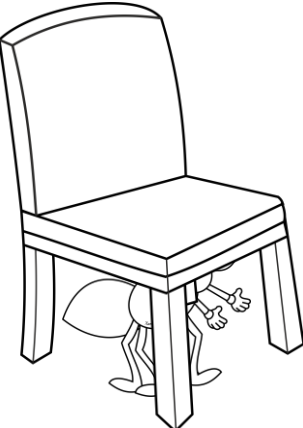

in
 on
 under



in
 on
 under

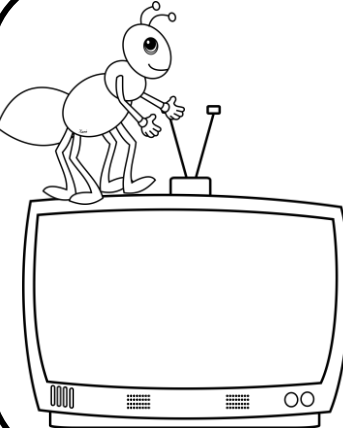

in
 on
 under



in
 on
 under

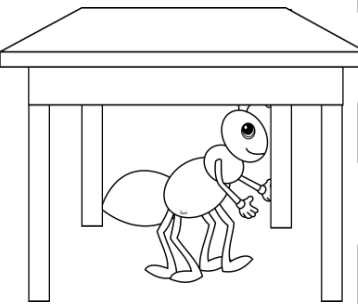

in
 on
 under

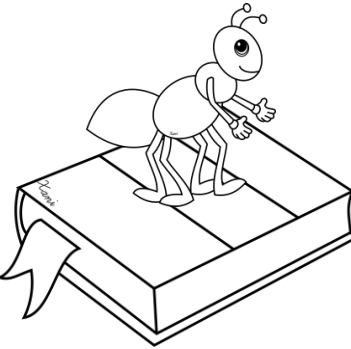

in
 on
 under

in on under

Worksheet number: fourteen

Name: _____

Date: _____

Read and circle the correct preposition.

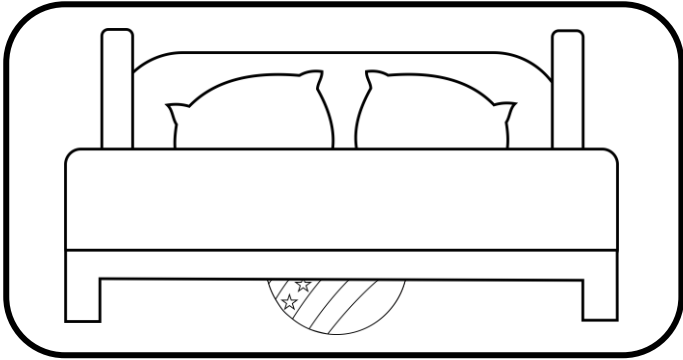

The ball is in/on/under
the bed.

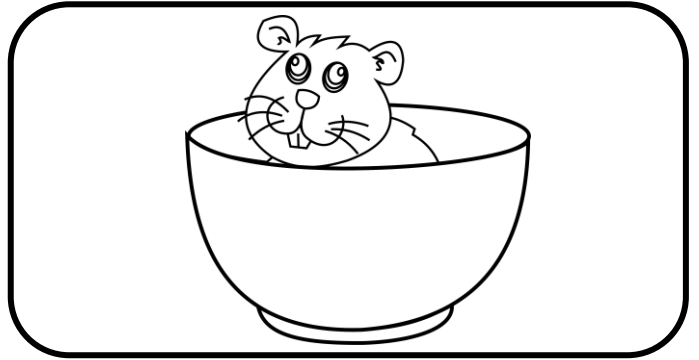

The hamster is in/on/under
the bowl.

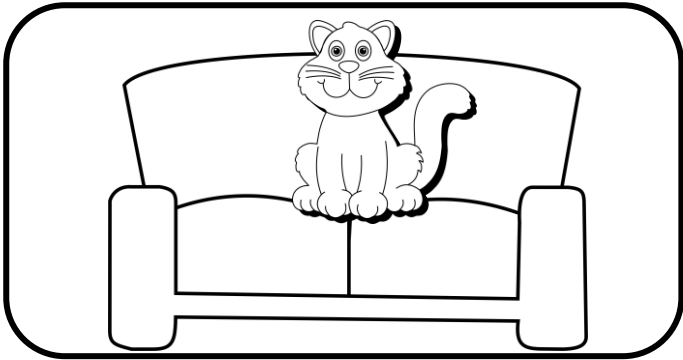

The cat is in/on/under
the sofa.

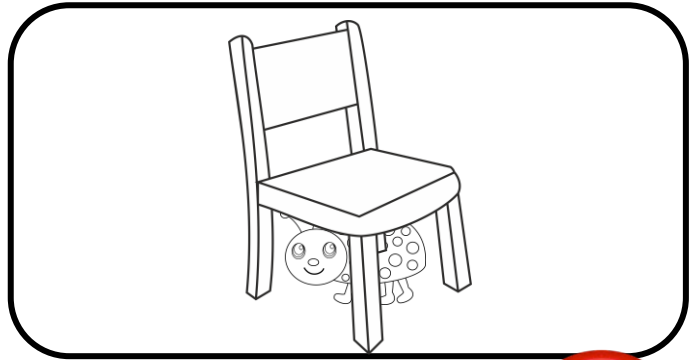

The ladybug is in/on/under
the car.

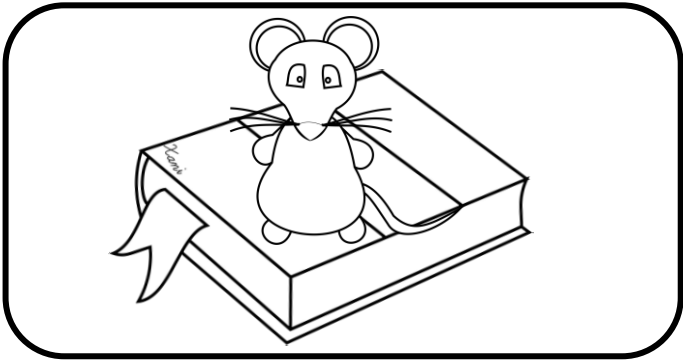

The mouse is in/on/under
the book.

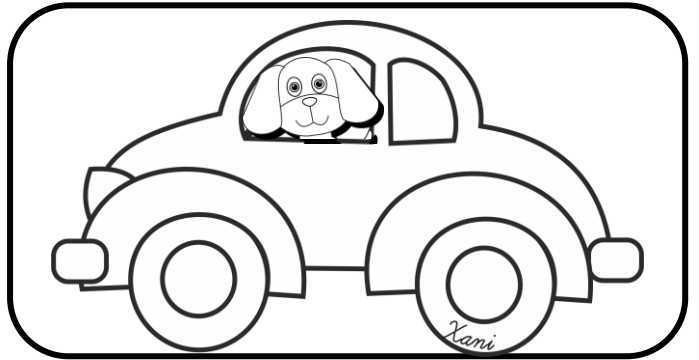

The dog is in/on/under
the car.

in on under

Worksheet number: fifteen

Name: _____

Date: _____

Read and draw...

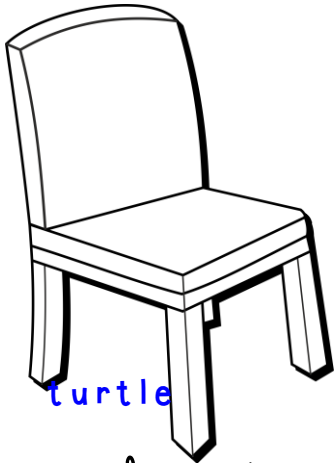

turtle

... a turtle under the chair.

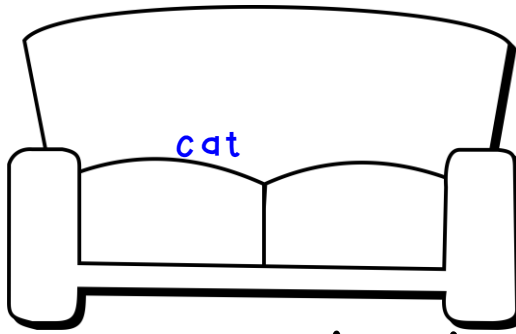

cat

... a cat on the sofa.

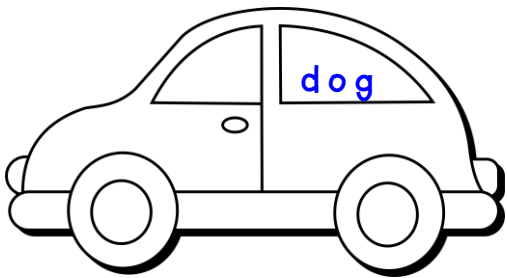

dog

... a dog in the car.

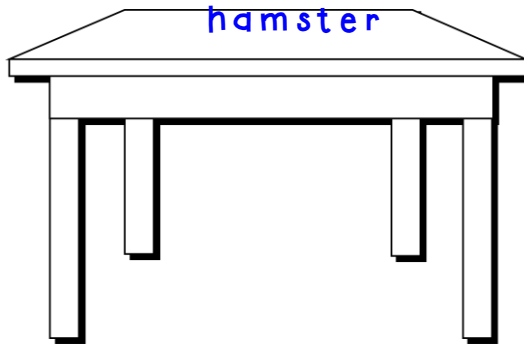

hamster

... a hamster on the table.

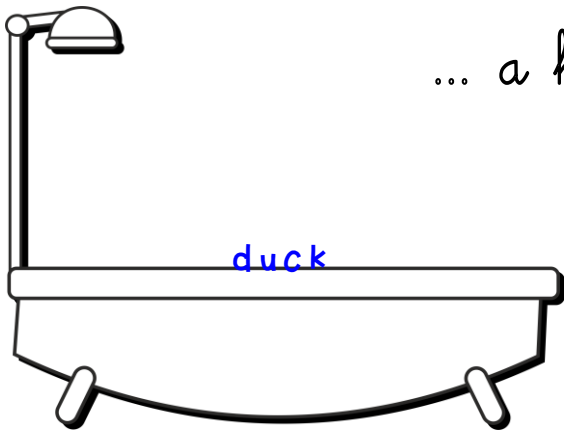

duck

... a duck in the bath.

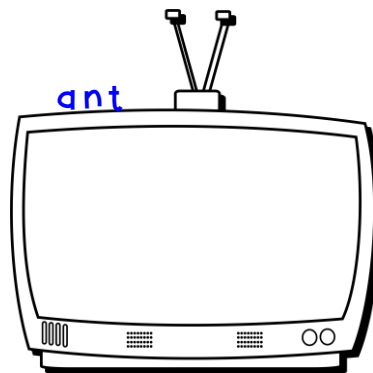

ant

... an ant on the TV.

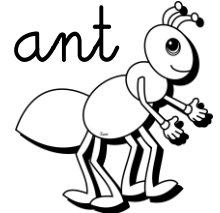

ant

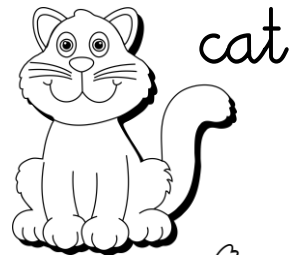

cat

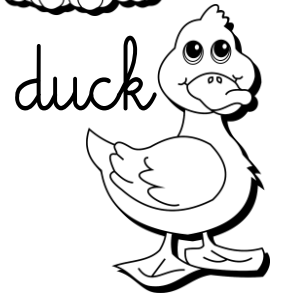

duck

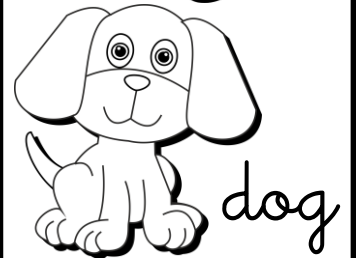

dog

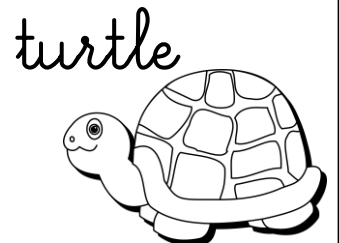

turtle

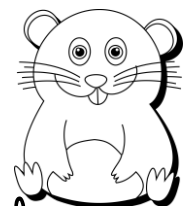

hamster

My House

My Picture Dictionary

Name: _____

Date: _____

Cut and paste the words.

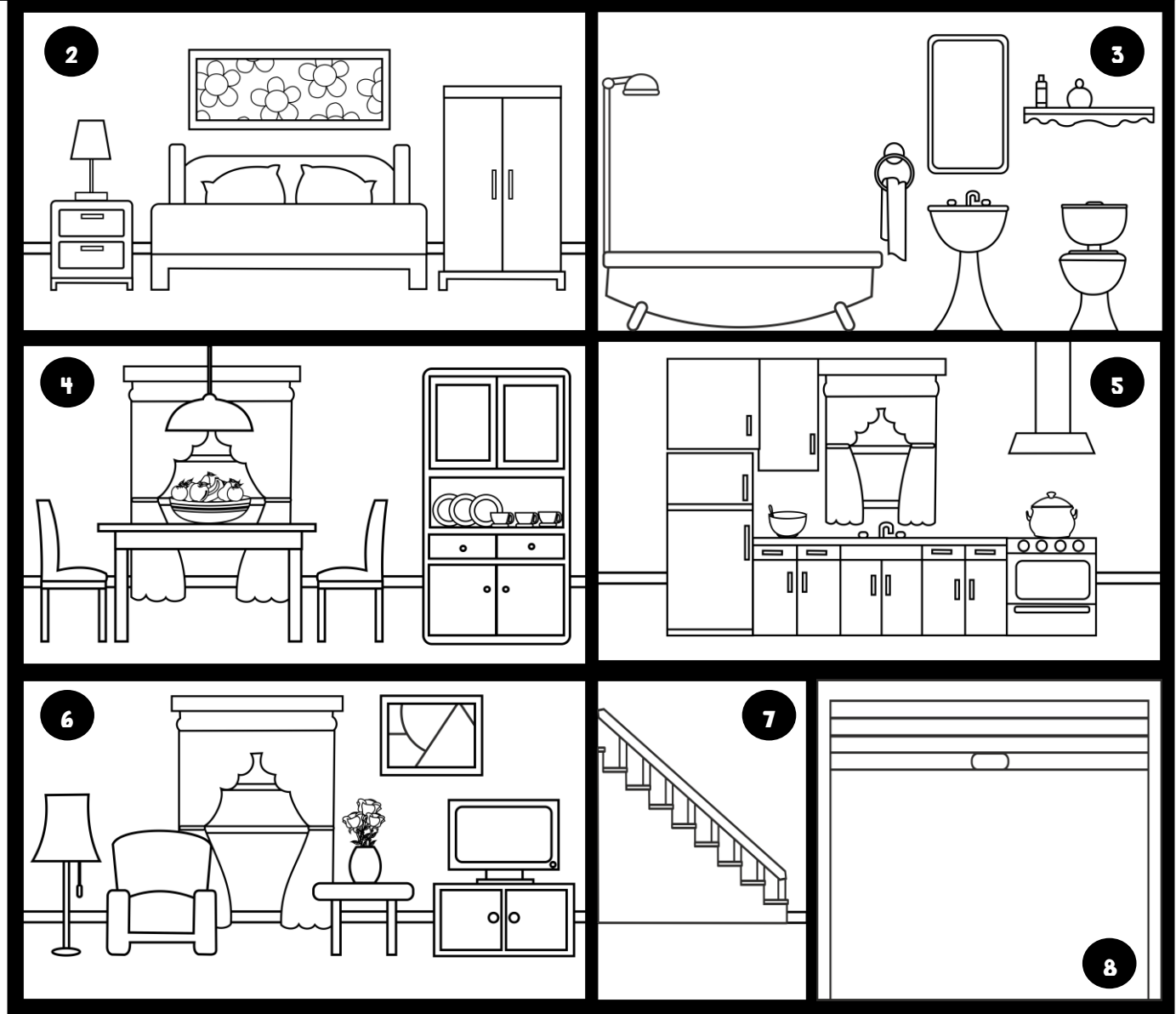
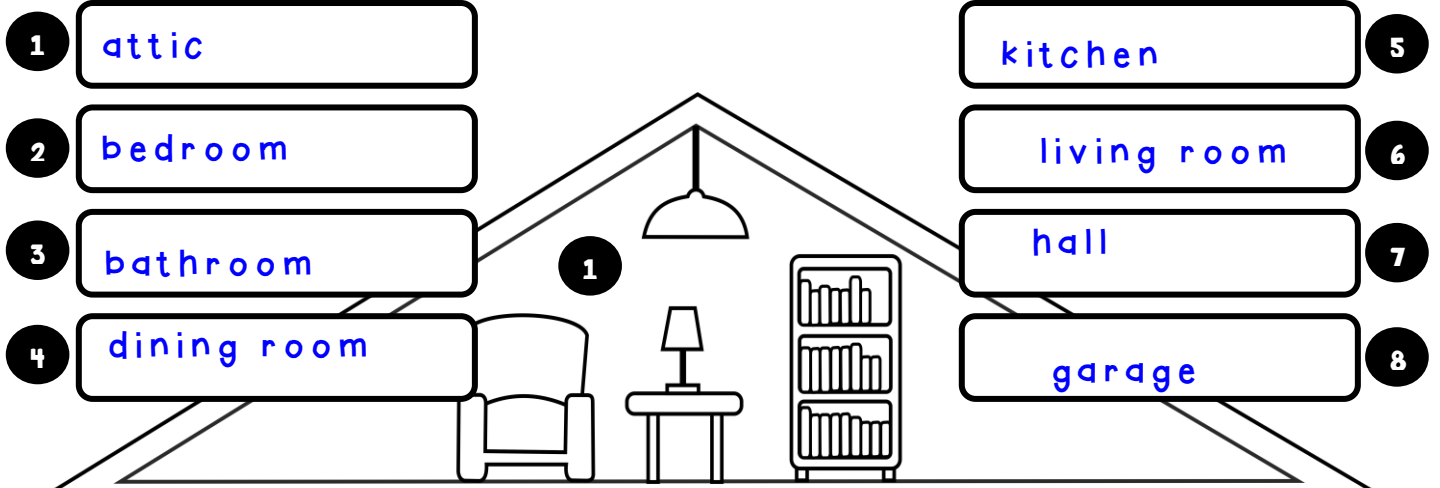

My House

My Picture Dictionary

Name: _____

Date: _____

Cut and paste the words.

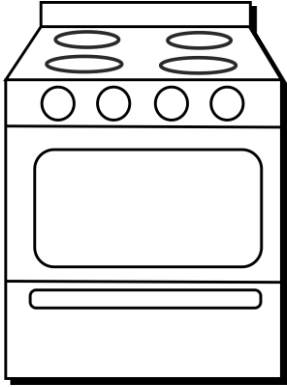

cooker

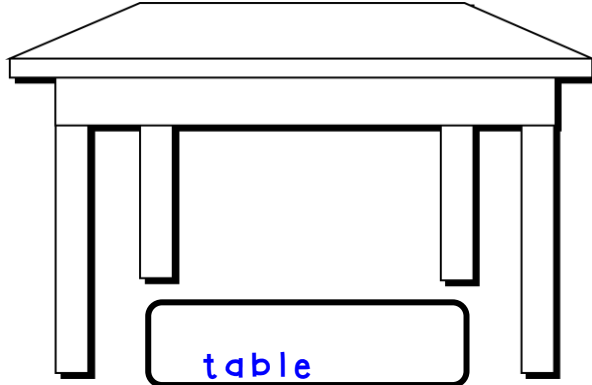

table

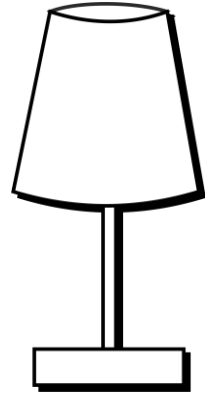

lamp

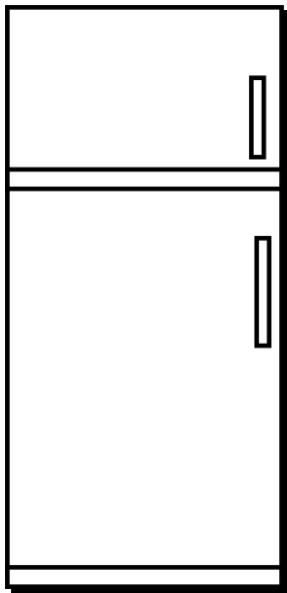

fridge

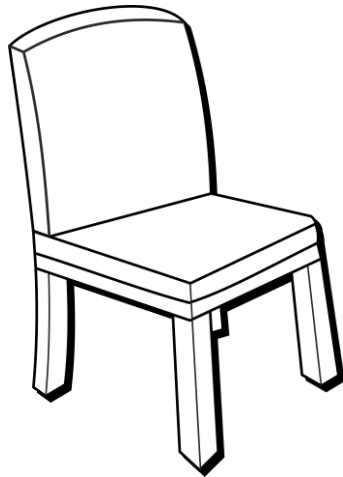

chair

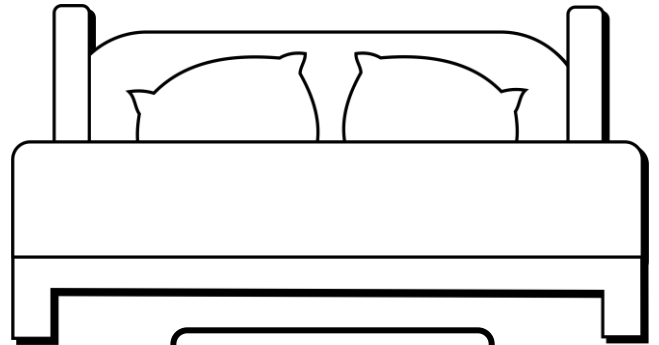

bed

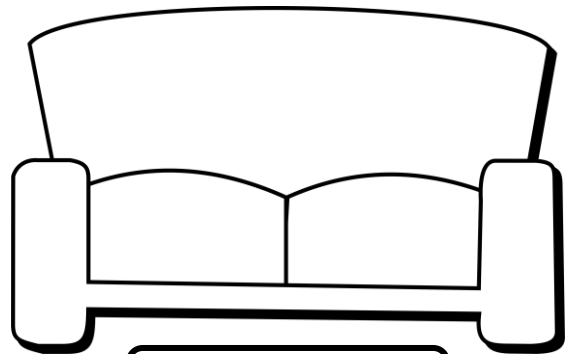

sofa

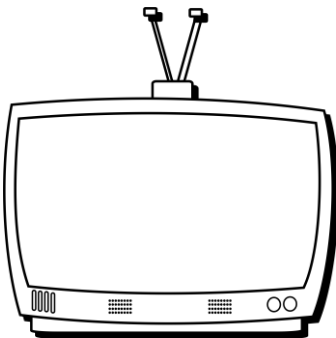

TV



flowers

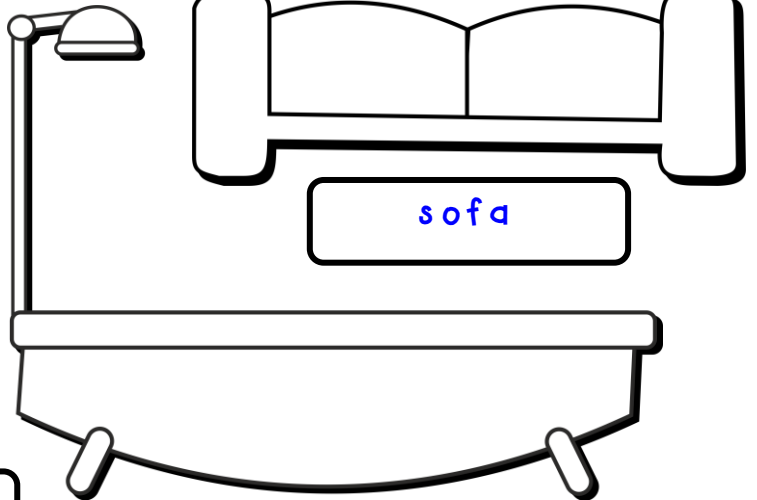

bath

My House

Name: _____

Date: _____



How am I doing?

Evaluation



I can name the parts of the house.

I can name some furniture.

I can say where people/things are.



I love my house!

